



Installation & User Manual

Contents

1. Safety precaution	2
1.1 Storage and installation environment	2
1.2 Battery safety guidelines	2
1.3 Warning signs and stickers	2
1.4 Emergency handling	3
1.5 Product description	4
1.6 Product introduction	4
1.7 Appearance and packing list	5
2. Installation guide	7
2.1 Environmental requirements	7
2.2 Installation physical requirements	9
2.3 Installation	10
2.4 Installation steps	11
3. Electrical connection	15
3.1 Interface Definition	15
3.2 Interface definition and preparation	16
3.3 Power line connection	17
3.4 Cable making	18
3.5 Cable connection	18
4. System debugging	19
4.1 System power-off	19
4.3 Display description	19
5. Maintenance manual / general troubleshooting	20
5.1 Routine maintenance	20
5.2 fault treatment	20
6. Warehouse storage guidelines	23
6.1 Packaging Guidelines	23
6.2 Storage	24
7. Disposal of used batteries	25
8. Detailed specifications	25
9. Contact Information	26

1. Safety precaution

Please read the manual carefully and operate in accordance with the safety precautions. Please refer to local safety regulations on items not covered in this manual. Electrical installation, maintenance must be performed by professional / qualified personnel.

















1.1 Storage and installation environment

- a) Handle the product gently, prevent from dropping
- b) Avoid open flame; keep away from flammables, explosives or corrosive chemicals
- c) Choose cool and dry place for storage and installation
- d) Prevent from water or humid intrusion
- e) Keep away from children and animals
- f) Do not step on the product packaging.
- g) Do not place any foreign objects on top of the battery pack.
- h) Do not store the battery pack upside down

1.2 Battery safety guidelines

- Prevent from electrostatic discharge
- Wear insulating gloves when handling batteries
- Do not energize auxiliary power during installation
- Check the polarity carefully before switching on the system
- Defected or damaged batteries shall not be charged or discharged

1.3 Warning signs and stickers

	Warning Generic hazard		Do not throw into the trash
	Warning High Voltage-Electrical shock hazard		Please recycle
	No flame		This side up
	No stepping on		User manual
	Warning High temperature		Protective Earth (connector)
	Warning High Voltage Wait 5 min till fully discharged		Protective Earth (general identification)
	Do not short circuit (cut off power)		Keep away from children
	Fragile		Do not get wet

1.4 Emergency handling

Wear personal protective equipment (PPE) such as goggles, face mask, insulated gloves and boots. Evaluate the situation before taking action. When it is safe to do so, disconnect external AC or DC power connection.

Damaged or deformed battery enclosure

Risk of chemical leakage (i.e. electrolyte) and internal short-circuit.



Warning

Deformed or severely damaged battery pack can lead to piercing of cell pouch (chemical leakage) or internal short-circuit (thermal runaway). The damaged battery pack can release toxic gas. Keep away from it.

In case of accidental skin contact, wash the skin thoroughly with soap and seek medical advice. For accidental eye contact, wash under running water (~15 minutes) and require immediate medical attention.

Fire hazard

If the fire is not from the battery or not spread to the battery, please use FM-200 or CO₂ fire extinguisher to put out the fire.

If the battery pack catches fire, do not attempt to put out the fire and evacuate immediately.

Seek medical advice in case of inhalation of pungent and toxic fumes.

Keep damaged batteries isolated and call your local fire department. Contact service department for further support.

Water damage

Risk of electric shock and internal short-circuit. In case of splash or water spillage, when it is safe to do so, dry the product. If any part of the battery system is submerged, keep away from water.

Do not reuse the submerged battery. Please contact service department for support.

1.5 Product description

InstaGen LV series is a stackable energy storage system, compatible with InstaGen Inverter. This document mainly provides product introduction, installation, debugging, maintenance, troubleshooting, packaging and transportation information.

1.6 Product introduction

- Residential energy storage system with lithium iron phosphate (LFP) technology
- Modular design; single battery system has 5.12 to 20.48kWh (1-4 pcs batteries)
- Indoor or outdoor installation (IP65)
- Expandable to 20.48kWh (four batteries in parallel)
- PCS communication interface: CAN or RS485
- Advanced battery management system (BMS) provides data collection, status monitoring and control to ensure the safety and reliability of the system.

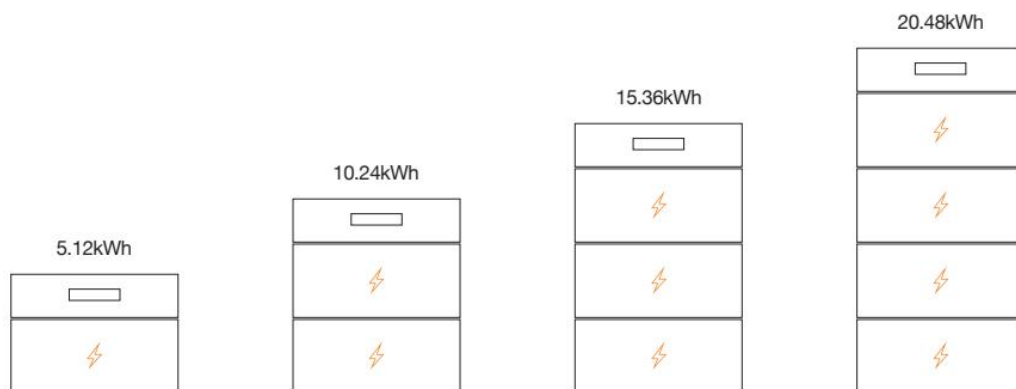

1.7 Appearance and packing list



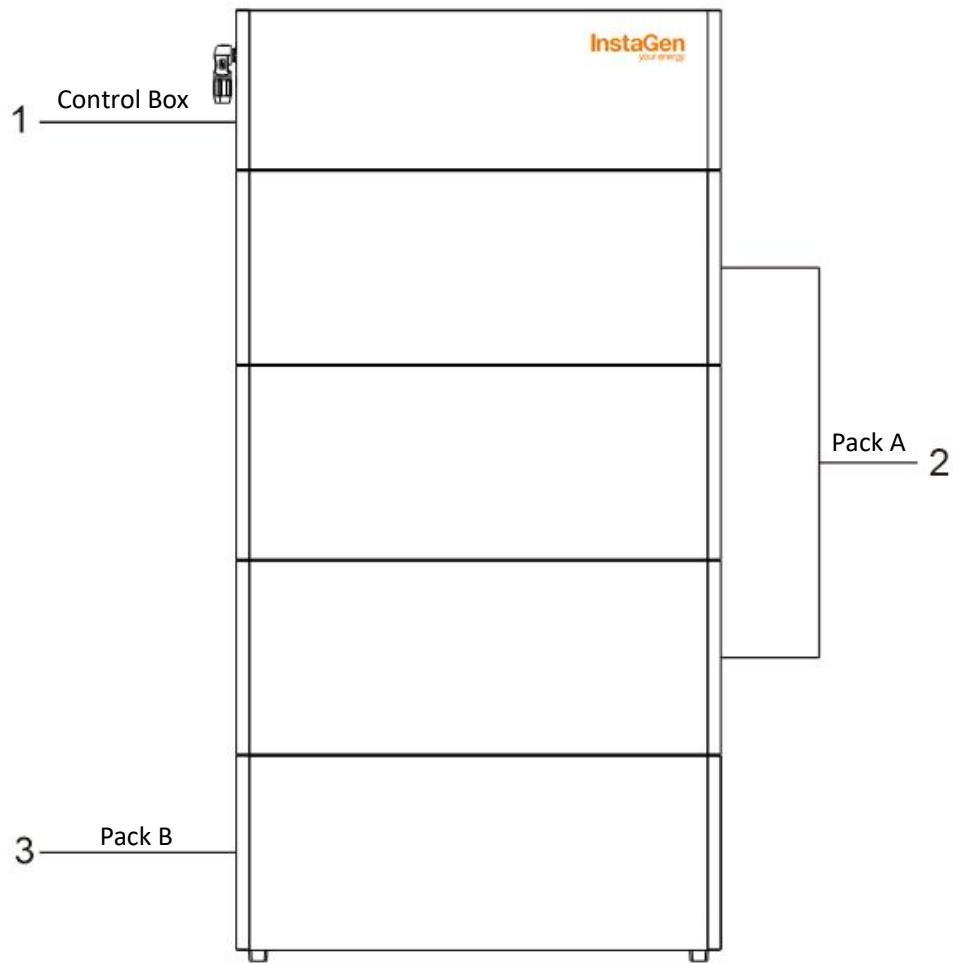



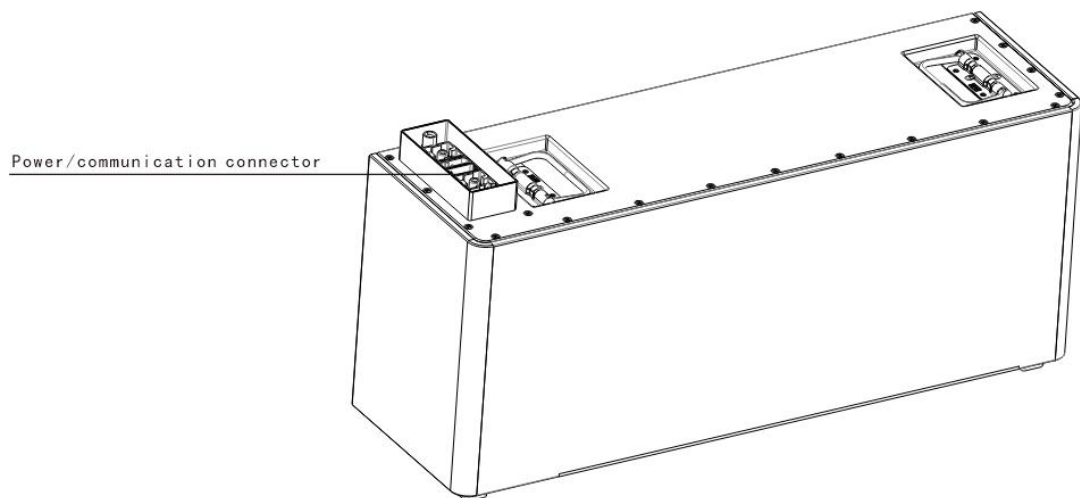



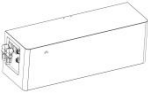

Overall appearance







Power/communication receiver







1. Control box

Control box packing list					
					
control box	certificate	User manual	Bracket 2	Screw (M4*12)	Screw (M4*6)
1PCS	1PCS	1PCS	2PCS	6PCS	1PCS
					
OT terminal	CP-8TR-35-150	CP-8TB-35-150	ZH-M20-RJ45-5T-200	Expansion screw(M6)	Bracket 1
1PCS	1PCS	1PCS	2PCS	1PCS	1PCS

2.PACK A

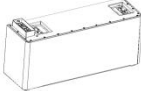
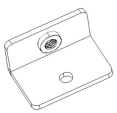
Packing list				
				
PACK A	Bracket 2	Bracket 3	Screw(M4*12)	certificate
1PCS	4PCS	2PCS	8PCS	1PCS

3.PACK B

Packing list				
				
PACK B	Bracket 2	Bracket 3	Screw(M4*12)	certificate
1PCS	2PCS	2PCS	6PCS	1PCS

2. Installation guide

2.1 Environmental requirements

- b. Environmental temperature: 0°C~+50°C (recommended: 10°C~35°C or 50°F~95°F).
- c. Environmental humidity: 10-95%.
- d. Altitude ≤ 2000m.
- e. For outdoor installation
 - a) Avoid direct sunlight
 - b) Avoid rain and snow
 - c) Avoid location susceptible to flooding
 - d) Install under shed if possible
 - e) Ensure ground clearance – feet are provided
- f. For indoor installation
 - a) feet clearance from doors, windows, driveway or other batteries
 - b) Keep away from heating devices
 - c) Prevent from corrosive chemicals
 - d) Prevent from water spillage
 - e) Avoid location susceptible to flooding
 - f) Ensure ground clearance – feet are provided

Consider location equipped with ventilation fans, smoke, heat, or flammable gas detector

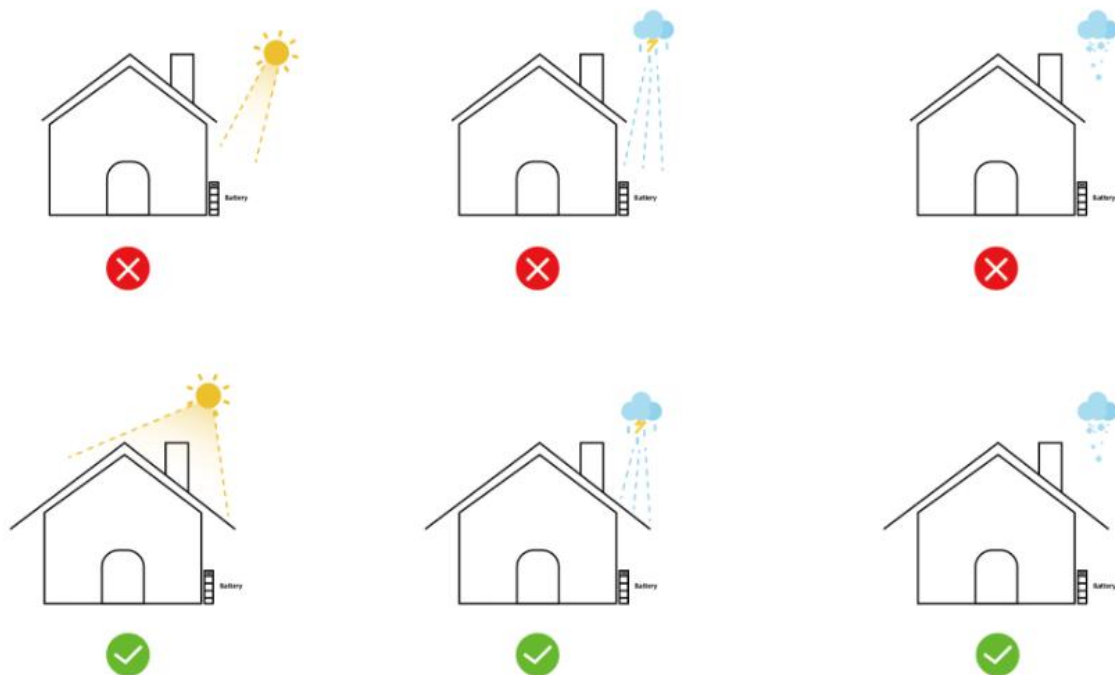



InstaGen LV performance degrades when environmental temperature is below 10°C (50°F) or above 40°C (104°F) degrees.

2.2 Installation physical requirements

Correct quantity for installation

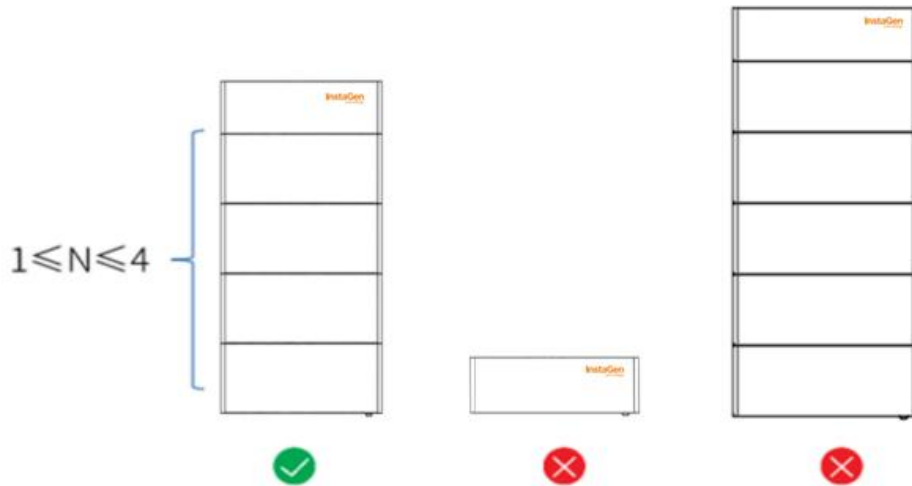



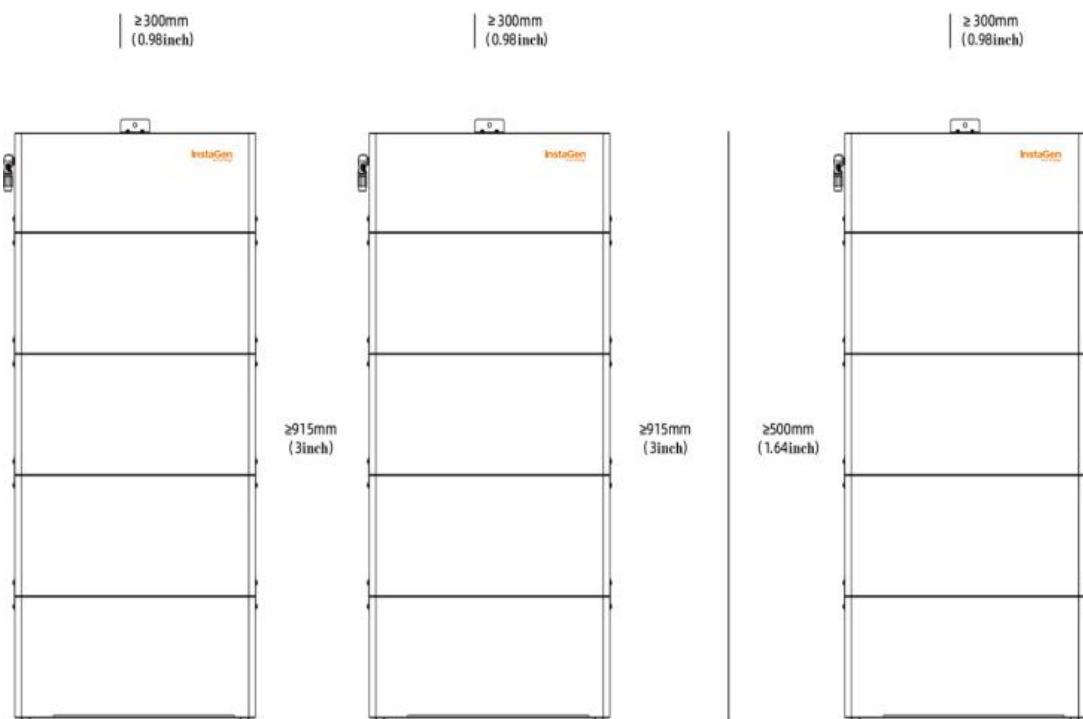





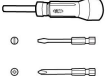

Installation clearance



2.3 Installation

Installation tool preparation

 detector	 Torque screwdriver	 Tape Measure	 Spirit level
 Crimping pliers	 Network cable pliers	 Wire stripper	
Personal safety equipment			
 safety gloves	 Goggle	 Dust cover	 Safety shoes

2.4 Installation steps

1. Bracket Installation

Use a cross screwdriver (torque screwdriver 5 N. M) Stent 2 on the fixed control box and the PACK.

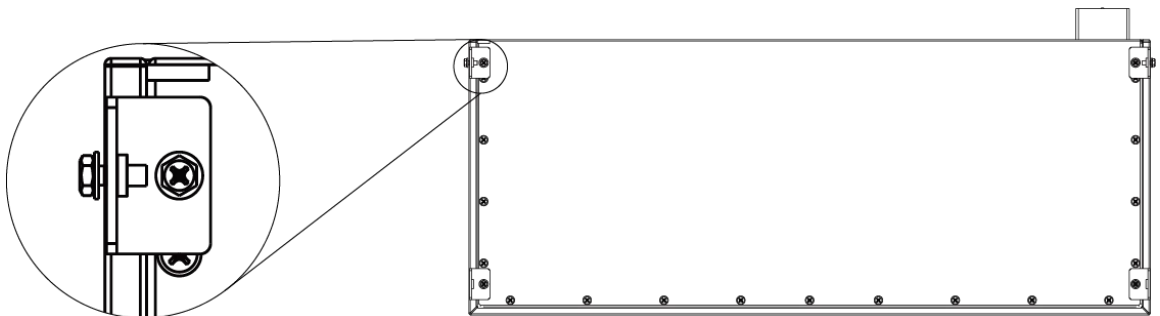
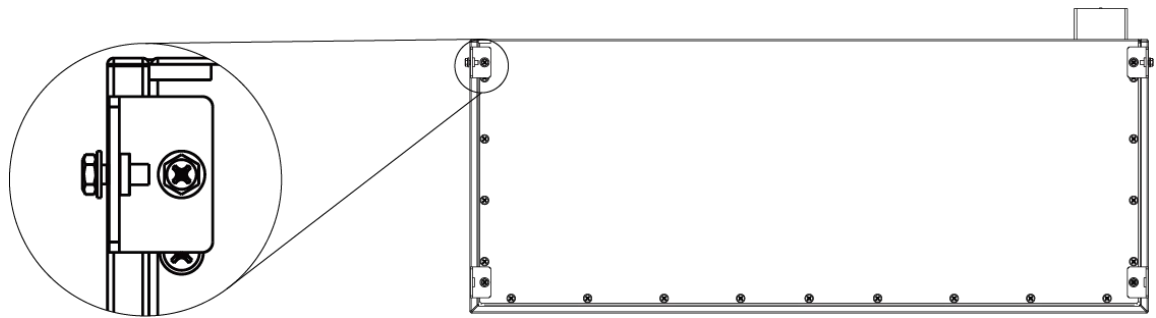
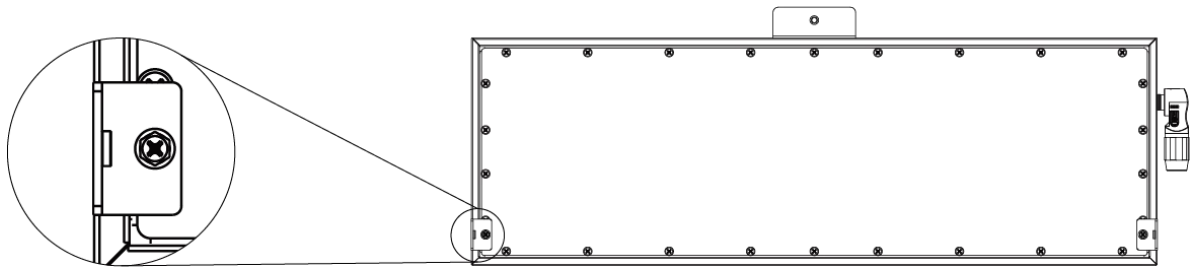

2. PACK B installation

2.1 If installing bracket, use a detector to detect whether there is cable or water tube behind the wall

2.2 The pack should be placed on a level ground ($0^{\circ}\sim 3^{\circ}$), parallel to the wall and keep a distance of at least 20mm. The handle must be used to lift the PACK off the ground for movement.

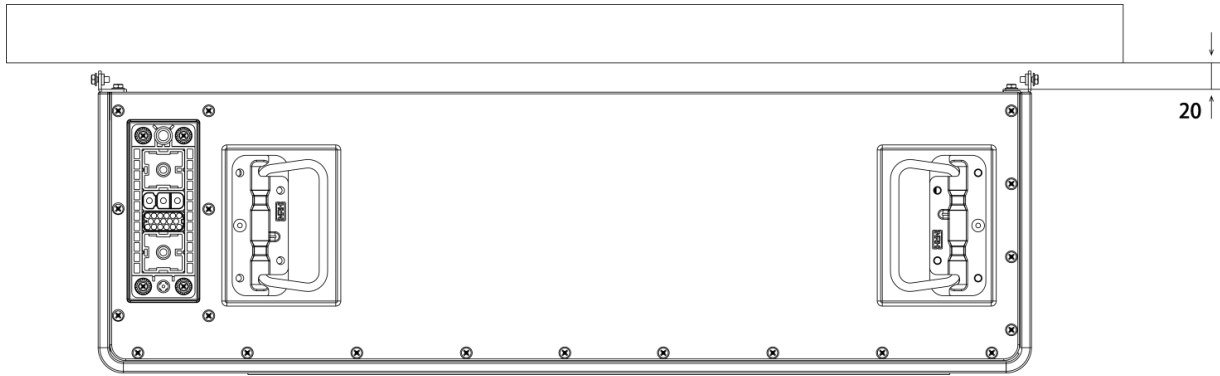

3. PACK A installation

When stacking battery modules, use a handle for installation. Firstly, align one end of the connector and slowly lower it until the shell is fully fitted.

Warning! Do not put down the end of non-connector first to avoid damage to the connector!

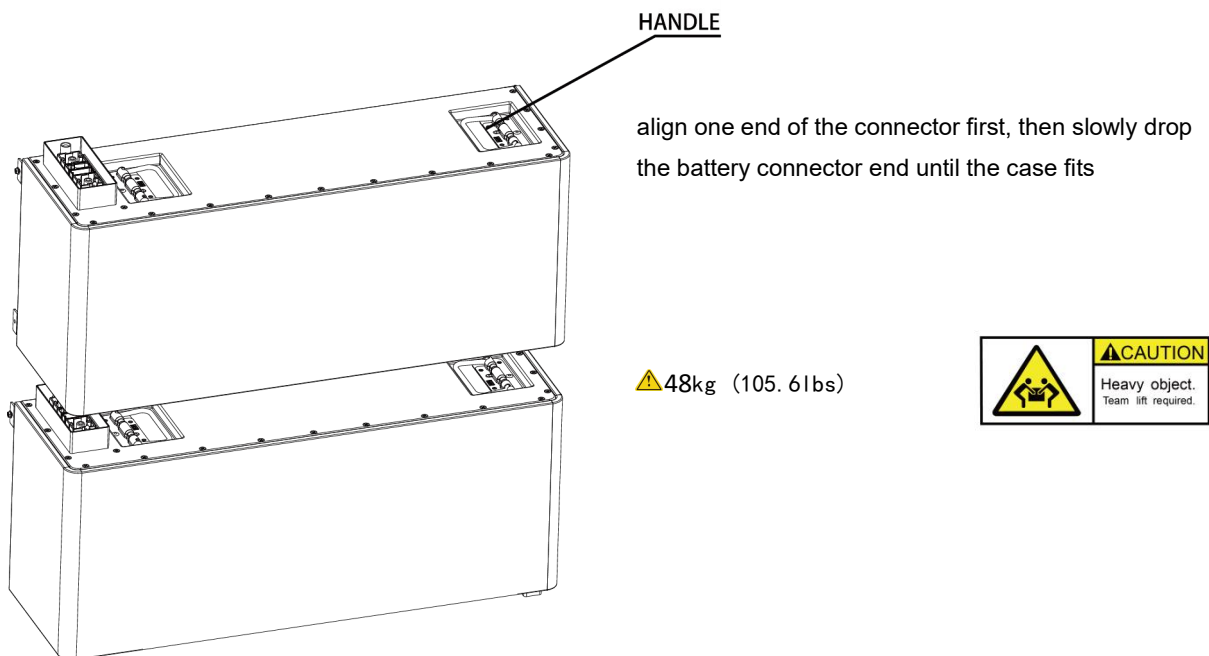

4. After installing PACK A, fix bracket 2 with a cross screwdriver (torque screwdriver 5 N.M). (The remaining battery modules are stacked layer by layer as shown in the figure)

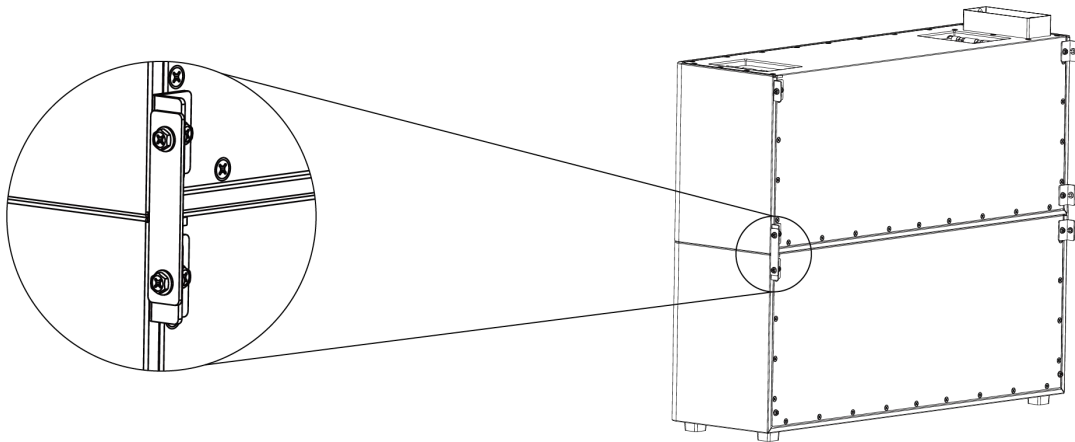

5. Install the top bracket

5.1. Position of the marker hole place the holder 3 against the wall on the corner holder and mark the hole with the marker.

5.2. The drill hole is shown below. When drilling, remove the bracket 3 and cover the PE bag on the product package with the battery module to prevent the dust from falling on the battery module during drilling.

5.3. Install one expansion screw and two fixing screws after drilling.

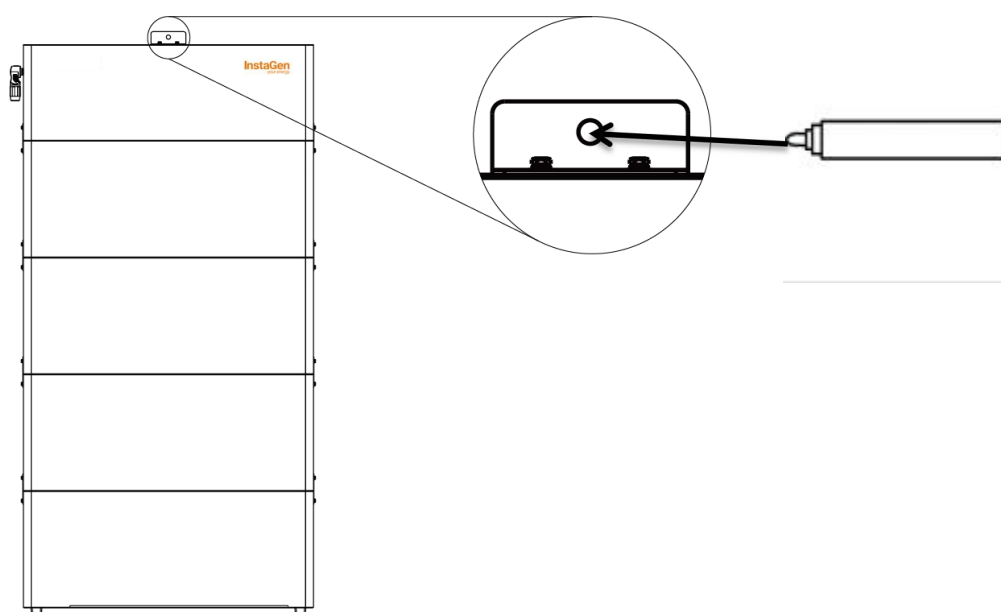

6. Installation is complete (up to 4 battery modules)

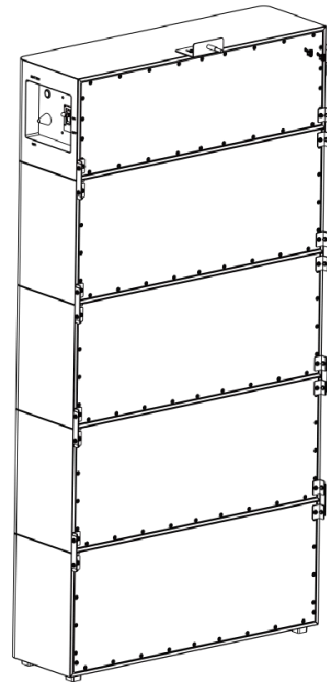
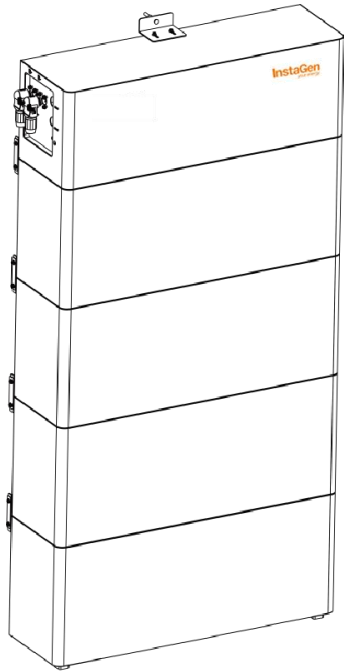

3. Electrical connection



NOTE: Before connecting cables, make sure all systems are powered off.

3.1 Interface Definition

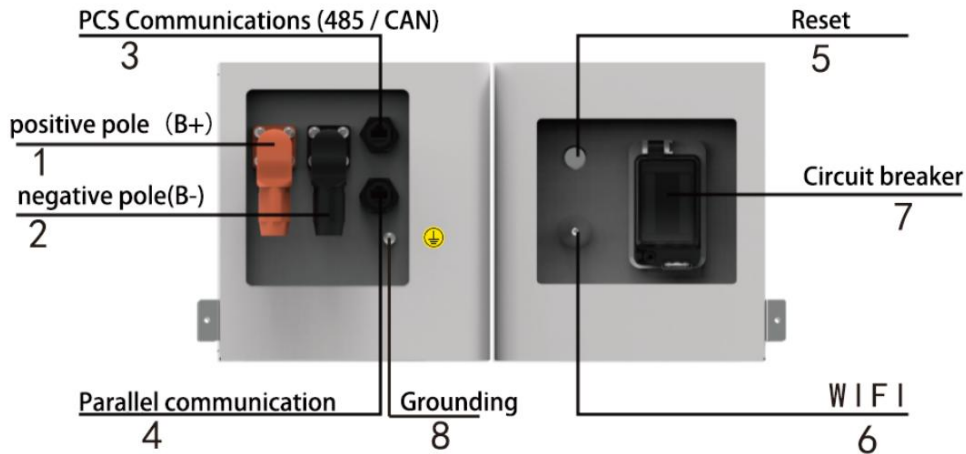

No.	Interface Name	Cable mark
1	Output positive pole (DC +)	B +
2	Output negative pole (DC-)	B -
3	PCS Communications (485 / CAN)	COM1
4	Parallel communication	COM2
5	Reset	RESET
6	WIFI	WIFI
7	circuit breaker	ON OFF
8	Ground connection	Grounding sign

RS485/CAN port pin definition of the control module:

COM1

Color	port	Pin	Function
Orange-white		1	L-485-B
Orange		2	L-485-A
Green- white		3	GND-L
Blue		4	CAN1H
Blue- white		5	CANIL
Green		6	GND-L
Brown-white		7	L-485-A
Brown		8	L-485-B

COM2

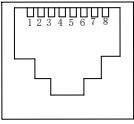
Color	port	Pin	Function
Orange-white		1	E-485-B
Orange		2	E-485-A
Green- white		3	GND-L
Blue		4	R-485-B
Blue- white		5	R-485-A
Green		6	GND-L
Brown-white		7	E-485-A
Brown		8	E-485-B

3.2 Interface definition and preparation

Ensure that it is firmly connected to the ground, and the grounding resistance is less than 4 ohms.

Cable specification	10AWG, yellow-green cable
Stripping size	8mm
Terminal specification	M4 OT terminal

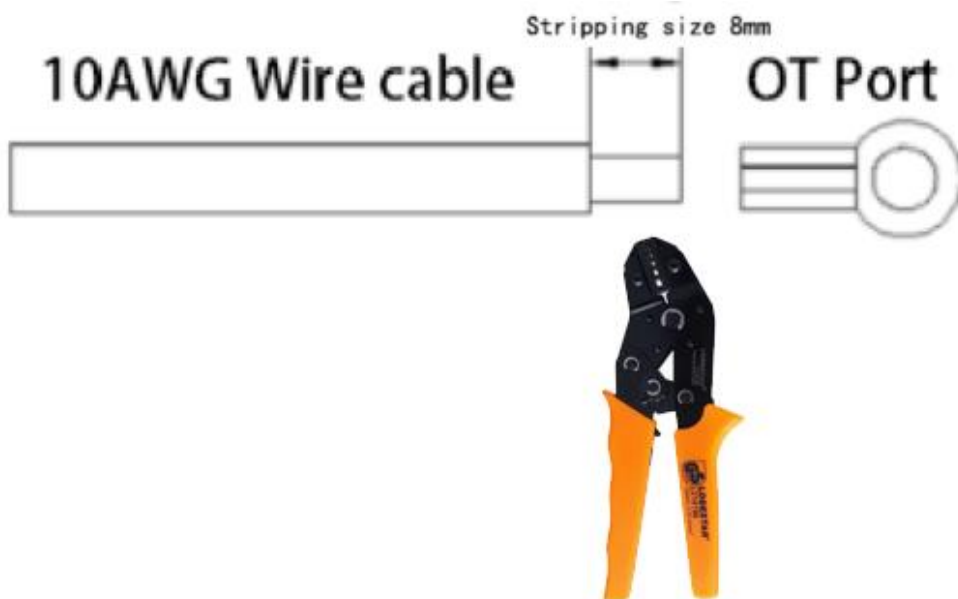

3.3 Power line connection

Check the cable connection battery polarity and ensure that it does not exceed the input limit 200v.

Connect the battery connector to the inverter. If installed correctly, there should be a "click" sound.

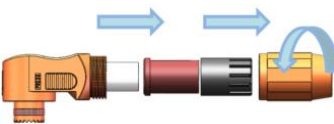
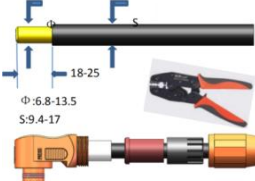
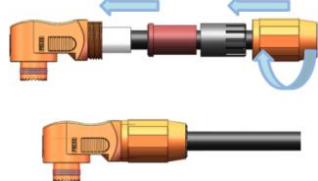
Step1	Step2	Step3
<ul style="list-style-type: none"> • Unscrew the plug lock sleeve • Press counterclockwise • Remove the black seal snap spine • Remove the red silicone seal case 	<ul style="list-style-type: none"> • Remove the outer cable insulation (generally 2-4mm) • Conductor core section: according to different specifications, can be pressed 25mm²--95mm²Cable, inner diameter range: 9.4-17mm² • The length of the peel line is generally 18-25 according to different specifications • Use a wire clamp to press 	<ul style="list-style-type: none"> • Check the reliability of the press to ensure that the press is tight with no gaps • Install the sealing sleeve and seal burger in the direction shown in the picture, and then rotate the lock sleeve clockwise to ensure that the lock sleeve is fully indented in place²
		

3.4 Cable making

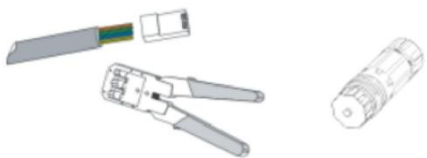
Step1	
Peel off the communication cable stripper with Ethernet, and direct the corresponding signal cable output. Pass the data communication cable through the gland ZH-M20-RJ45-5T-200, insert the RJ 45 plug in the correct order, and press it with a crimp.	

3.5 Cable connection

3.5.1. Cable connection of single equipment

The wiring of the equipment is shown in the figure below. For the connection to the inverter side, please refer to the inverter user book.

4. System debugging

4.1 System power-off

All cables must be connected correctly.

1. Turn off the battery switch on the inverter side (if the inverter has a separate battery switch).
2. Press and hold the one button start button for 3 seconds to turn off the circuit breaker switch, and the indicator light on the light board will turn off (when turned to the OFF position).

4.2 System power-on

1. Turn on the inverter side switch (if the inverter has a separate battery switch).
2. Turn on the control module circuit breaker switch. (Set to the ON position)
3. Press and hold the one button start button for 3 seconds (if it is the first time to start, please double click the one button start button at a constant speed to assign the battery pack address information)

4.3 Display description

1. The green light flashes in charging mode (frequency 1 Hz);
2. The green light is always on in discharge mode;
3. In standby mode, the blue light will be on for 3 minutes, then it will be off for 3 minutes and on for 10 seconds;
4. The red light is always on when the fault occurs.

Indicator light

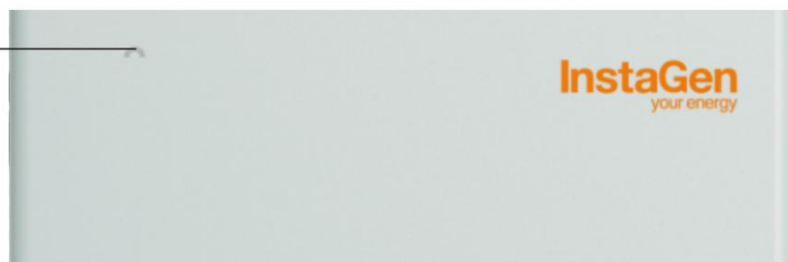

5. Maintenance manual / general troubleshooting

5.1 Routine maintenance

The battery needs to be recharged every 6 months if not installing

From the date of shipment from the manufacturer, the battery needs to be maintained at a maximum interval of 6 months; the requirements for the recharge interval after the battery is empty are as follows:

Environmental temperature (45,50) °C, should be recharged within 7 days;

Environmental temperature (35,45) °C, should be recharged within 15 days;

Environmental temperature $\leq 35^{\circ}\text{C}$, should be recharged within 30 days.

When the device is placed unused, the battery SOC should be in the range of 45%~55%, and battery output should be disconnected to prevent the battery from draining.

During the storage period of the system, professionals should regularly check the system to check whether the lines are loose or fall off and clean the surface of the system; if any defects are found, please contact your wholesaler.

5.2 fault treatment

Fault	Cause	Solution
POWER button no response	Damaged power button, damaged cable, or poor contacts	Please contact the supplier to repair or replace the control box
Short discharge time	Battery power is insufficient	Keep the product charging continuously, and keep the energy storage battery system fully charged
	Low ambient temperature	Ensure that the product works within the recommended appropriate temperature range
	Product overload	Check the load status and remove non-essential loads
	Battery aging and capacity decline	To replace the battery, contact the supplier for the battery and its components
Unable to charge and discharge	internal fault	Log in to Insta APP, view the fault information, and contact the supplier
	The battery reports a charging or discharge protection fault	Log in to Insta APP, view the fault information, and contact the supplier

	After the battery is discharged to the SOC protection value, it is charged for a period of time before discharge.	The battery is charged to the SOC value set at the restart
--	-------------------------------------------------------------------------------------------------------------------	------------------------------------------------------------

	Battery overheating	For more than 3 hours at room temperature
After the system is started, the display is not on	Displays failed	Please contact the supplier to repair or replace the control box
Battery communication is abnormal	Communication disconnected	Check that the battery pack is installed reliably, and confirm that the battery is abnormal through the battery status indicator on the light board
The system status lamp on the lamp board is abnormal and flashes every 1S	Other faults	Log in to Insta APP, view the fault information, and contact the supplier
The Wi-Fi connection is abnormal	<ol style="list-style-type: none"> 1. The Wi-Fi connection is misconfigured 2. Abnormal Wi-Fi module and abnormal line connection 	<ol style="list-style-type: none"> 1. Check whether the battery Wi-Fi connection configuration is correct 2. Check whether the antenna is installed or connected reliably
The inverter is energized through the battery for the first time, and the battery reports for short-circuit protection	The parallel capacitance value of the inverter battery side input terminal is relatively large	Battery protection can be restored automatically
The inverter cannot start up	Battery voltage is too low, or the SOC is lower than the shutdown protection value	After starting the inverter from the grid, charge the battery

6. Warehouse storage guidelines

6.1 Packaging Guidelines

- a. As this product contains lithium-ion batteries, it must be packed as required when shipping by sea or air. The packaging requirements for hazardous packaging of battery products are as follows:
- b. Packaging manufacturers with dangerous goods packaging qualifications are responsible for providing product packaging, and the packaging manufacturers have records in the local commodity inspection bureau;
- c. After the packaging manufacturer completes the packaging, the supplier needs to submit an application to the Commodity Inspection Bureau. The Commodity Inspection Bureau will provide the "Dangerous Packaging Product Use Inspection Form" and the "Dangerous Packaging Product Performance Inspection Form", and complete the dangerous packaging commodity inspection;
- d. Packaged products should be placed in dry, dust-proof and moisture-proof packing boxes;
- e. The product name, model, quantity, gross weight, manufacturer, and date of manufacture should be marked on the outside of the packing box.
- f. Necessary signs such as "upward" and "fire protection" shall meet the requirements of GB/T 191;
- g. Packaging step

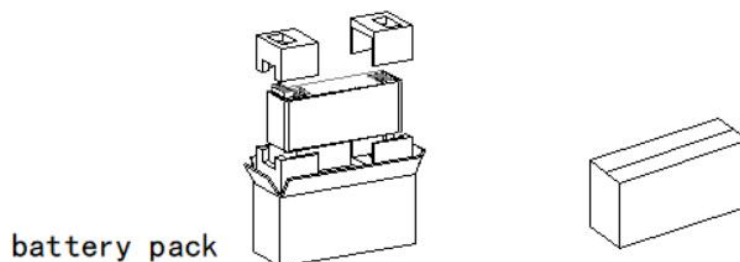
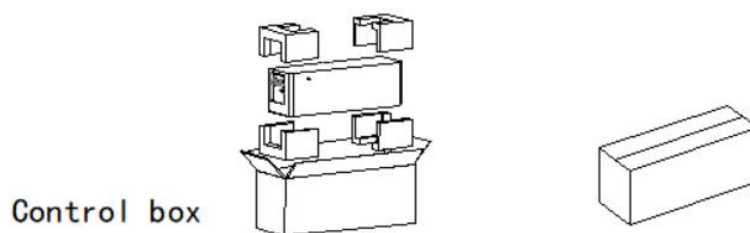

6.2 Storage

This product contains a lithium-ion battery. When storing, pay attention to the power of the battery module and the temperature and humidity of the storage environment of the whole machine. The battery pack is usually stored in a clean, dry, ventilated room with an Environmental temperature of $25^{\circ}\text{C}\pm 5^{\circ}\text{C}$, a relative humidity not exceeding 75%, and a state of charge of 45% to 55%. Avoid contact with corrosive substances, keep away from fire and heat sources.

7. Disposal of used batteries

Disposal of the system must comply with applicable local regulations for the disposal of electronic waste and used batteries.

- Do not dispose of the battery system with your household waste.
- Avoid exposing the battery to high temperatures or direct sunlight.
- Avoid exposing batteries to high humidity or corrosive environments.
- For more information, please contact the original manufacturer.

8. Detailed specifications

System specifications

Item	parameter			
System model	InstaGen LV-5	InstaGen LV-10	InstaGen LV-15	InstaGen LV-20
Parallel battery	1P16S	2P16S	3P16S	4P16S
Rated energy	5.12kWh	10.24kWh	15.36kWh	20.48kWh
Maximum discharge current	50A	100A	150A	150A
Dimensions W*H*D,mm	665*200*503	665*200*770.7	665*200*1038.4	665*200*1306.1
Net weight	61.5kg	109.5kg	157.5kg	205.5kg
Rated voltage	51.2V	51.2V	51.2V	51.2V
Operating Voltage	44.8~57.6V	44.8~57.6V	44.8~57.6V	44.8~57.6V
External communication	CAN/RS485			
Cycle life	8000 times (25℃,0.5C/0.5C, DOD 90%, SOC 70%)			
stackable	Up to 4 battery modules			
Protection class	IP65			
Operating temperature	Charging [-10,50] °C; Discharging [-20,50] °C			
Working humidity	10%~95%RH			
Working altitude	≤2000 m			
Certification	IEC62619, UN38.3			

9. Contact Information



InstaGroup Limited

Add: Insta House, Ivanhoe Road, Hogwood Business Park,
Finchampstead, Wokingham, Berkshire, RG40 4PZ, UK.

Tel: 0800 526 023

Email: info@instagroup.co.uk